



FEATURING

TITAN[®] STEEL



HIGH PERFORMANCE BUILDING MATERIALS FOR SWIMMING POOLS



Swimming is Just Too Cool!

Swimming pools – a great way to entertain guests, relax, and stay in shape. Beat the summer heat without ever leaving home. Corral the kids for the summer or turn your backyard into your personal oasis. Now is the time to make your family’s dream come true. Day after day, your new swimming pool will bring years of unforgettable fun and excitement.

Only Alpha Pool Products does not manufacture or endorse diving boards or slides. Any use or installation of diving boards or slides must be in strict compliance with each such equipment manufacturer’s specifications and recommendations, the Pool & Hot Tub Alliance standards, as well as all local building codes and regulations; and recommendations from the American Red Cross and the Consumer Product Safety Commission.

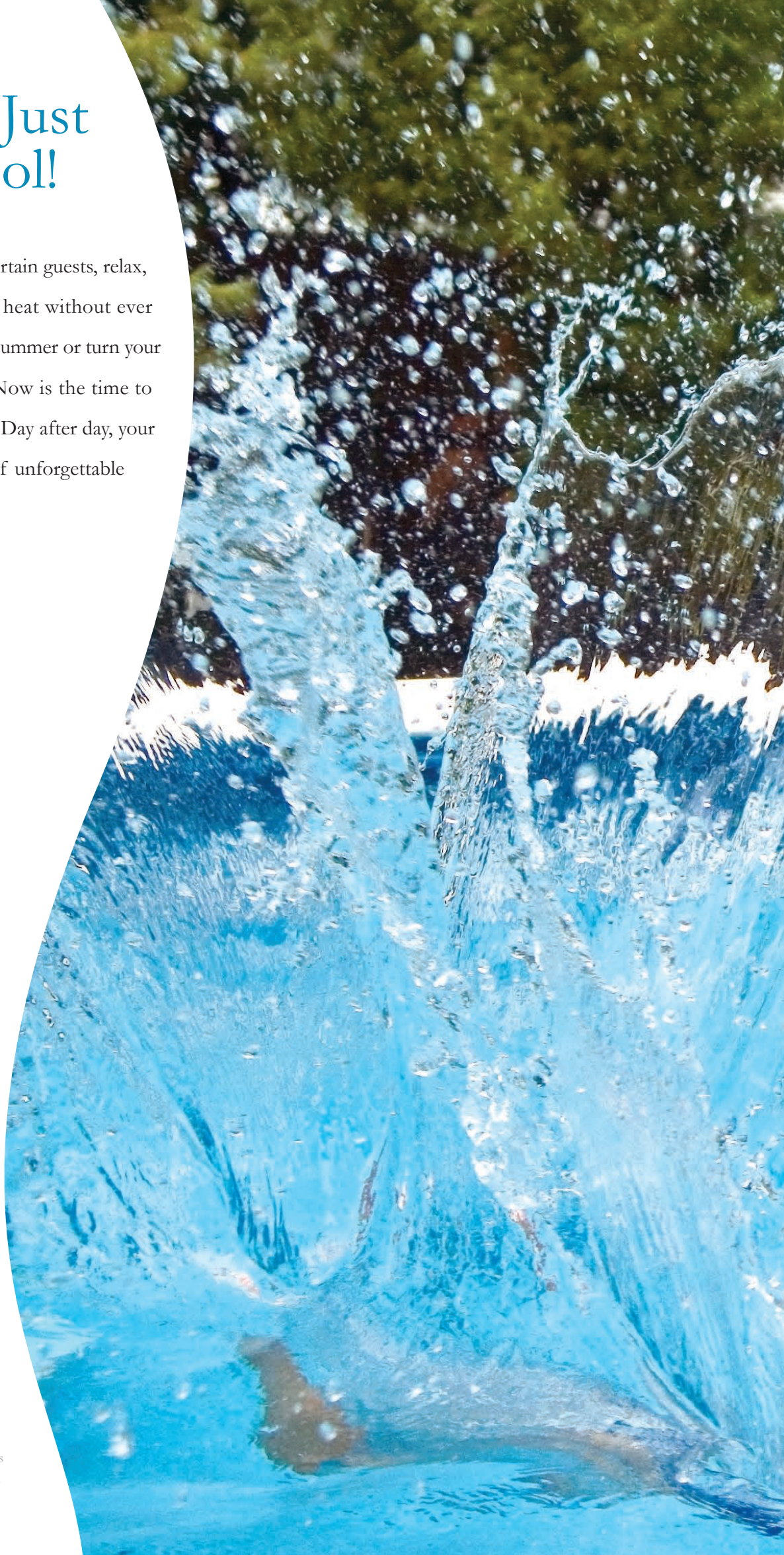



Why Buy an OAPP Pool?

Intelligent machines...unparalleled accuracy

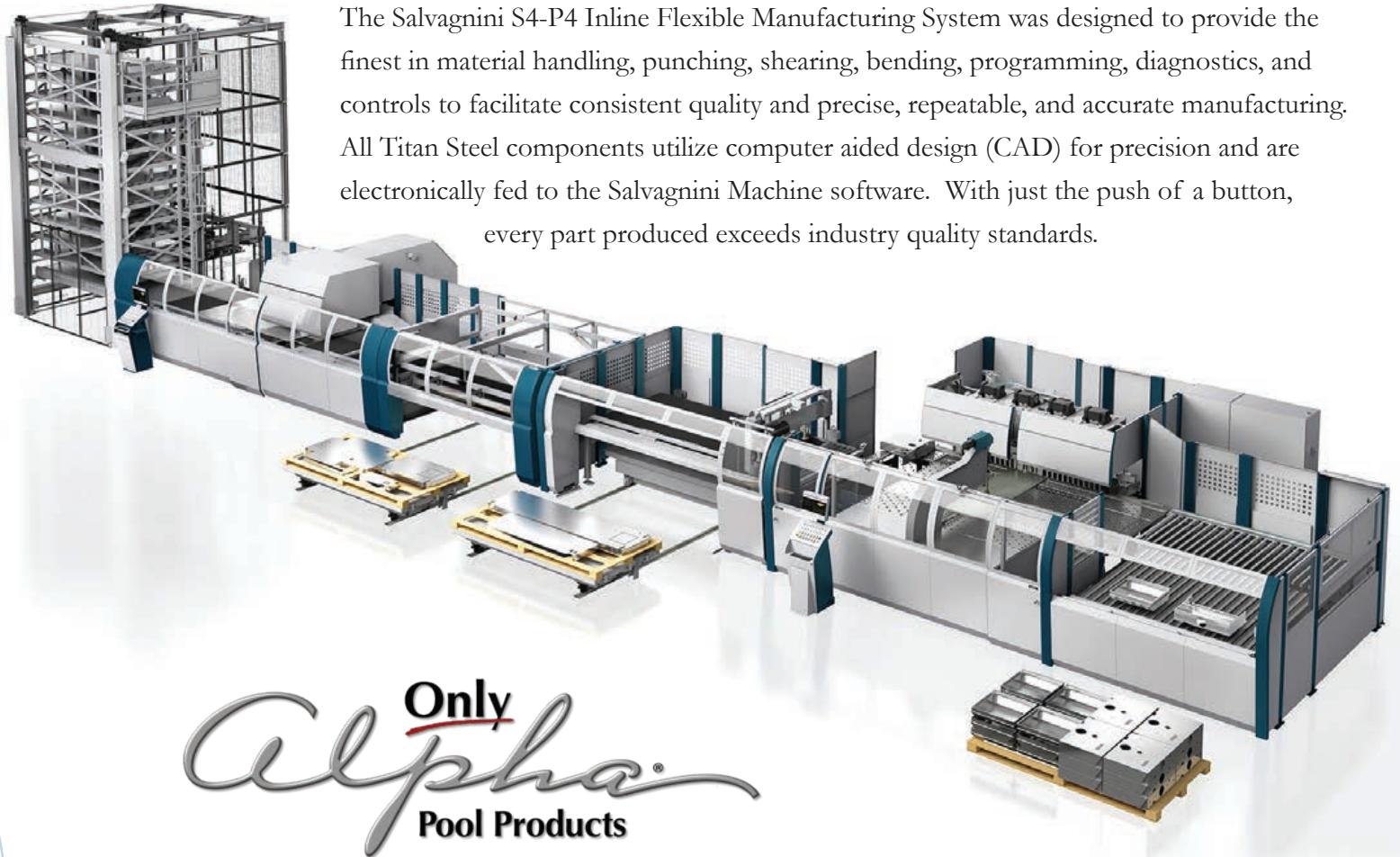

The Salvagnini S4-P4 Inline Flexible Manufacturing System was designed to provide the finest in material handling, punching, shearing, bending, programming, diagnostics, and controls to facilitate consistent quality and precise, repeatable, and accurate manufacturing. All Titan Steel components utilize computer aided design (CAD) for precision and are electronically fed to the Salvagnini Machine software. With just the push of a button, every part produced exceeds industry quality standards.

Only the Best Materials...

World's Strongest, Most Corrosion-Resistant Steel Panel

- 14 Gauge Galvanized Steel
- 42" to 52" Wall Heights
- New, up to 6' Max Panel Length on 48" Walls
- 5" Flange
- Turnbuckle Bracing & Optional Deck Supports

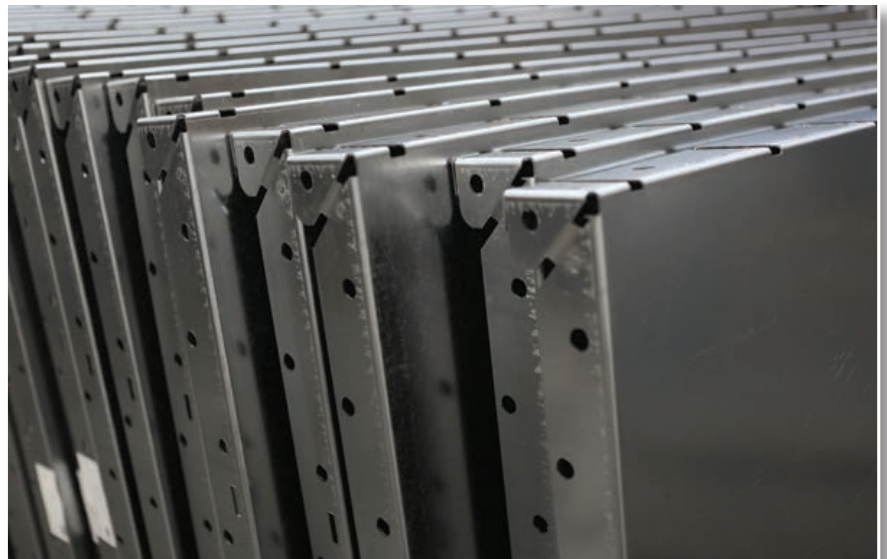

Complete Pool Package

5-Day Manufacturing Lead Time complete with liner delivered safely and quickly anywhere!

Carefully loaded and shrink-wrapped pallets are easily identified and ready to build on your jobsite. Our fleet of delivery trucks and fulfillment centers means you are assured your job will be onsite when you're ready for it.

Following through on our commitment to provide ONLY the best by adding Inground Pool Liners to our in-house offering. This allows us to provide the BEST turn-key pool structure and liner package in the business.



Only the Best People

Our Experienced and Dedicated Workforce are the Best!



Having a dedicated workforce means our team members are constantly striving to achieve perfection in every aspect of their jobs. Our craftsmen have been with us for years and are cross-trained to be experts at everything they do. They utilize the state-of-the-art equipment that produces our steel panel components and take incredible pride in all facets of their jobs.

...We Are OAPP

Evaluated and in Compliance with over 30 codes and standards including International Building, Residential, and Swimming Pool & Spa



All of our highly-engineered panels have been ICC-ES Evaluated, receiving a comprehensive compliance report. This underscores our unwavering commitment to providing Only the BEST building materials, held to the most rigorous quality control and building standards in the WORLD.



Scan this QR CODE to view our ICC-ES Evaluation Report

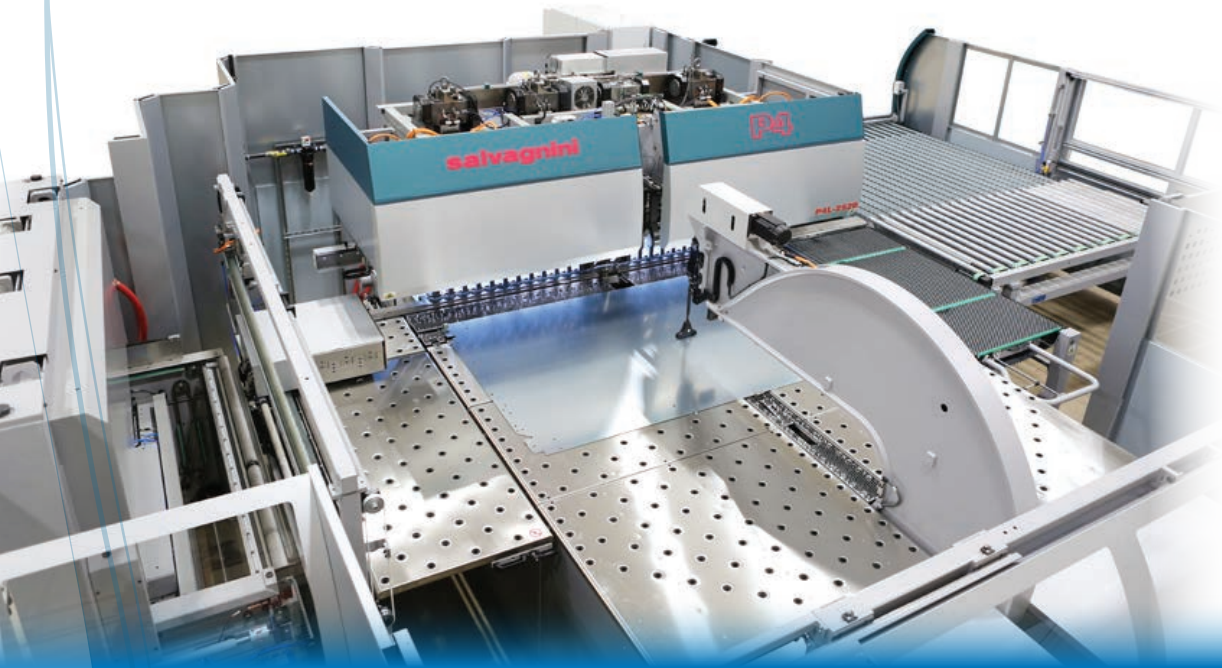

Alpha Advantage Shield Technology

Introducing the "new standard" in steel building materials



What Is It?

A proprietary clear coat that contains thermosetting properties that when applied on top of Only Alpha Pool Products highly galvanized steel components, is designed to enhance corrosion resistance extending the longevity of our building materials.

Real Results

Independent engineers conducted a side-by-side comparison test of Only Alpha Pool Products' steel panels and the industry-wide steel panels. They found our competitors' panels ended up with 70% white rust while the Alpha Advantage Shield protected the panels attributing only 5% over the same period of time.

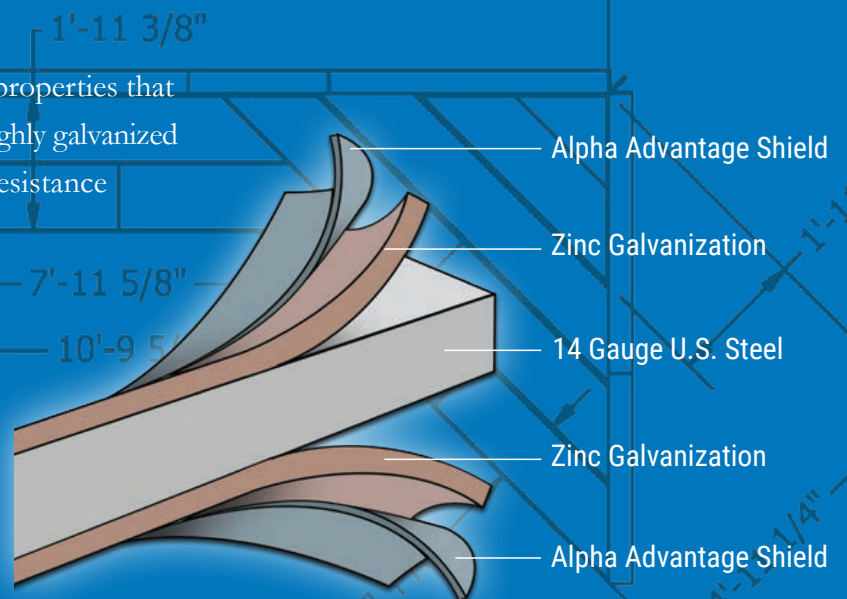

Significant findings when it comes to your investment.

The strength of our pool construction components can be attributed to one name — Titan Steel.

This uniquely designed and engineered wall and bracing system has been created to maximize the strength of steel and the technology of the 21st Century. New advancements in design and engineering have made Titan Steel components even better than anyone could imagine, giving you an unparalleled product that will be enjoyed for many years. The strength of our pool construction components can be attributed to one name — Titan Steel.



What makes it so strong?

- Highest quality certified 14-gauge copper bearing steel from **ONLY USA** suppliers
- Corrosion resistant galvanized steel coated with **Alpha Advantage Shield** for Extra Corrosion Protection
- 5" top & bottom flange utilizing the revolutionary SPERT technology with internal stud welded and SPERT rib supports
- Extra strong panel braces & deck supports



We know it gets buried underground and you'll never see it again, but you'll know with every splash that your new pool is constructed with strength and engineering unparalleled in the swimming pool industry. For this reason the Titan Pool wall structure includes a one-time transferable lifetime warranty.

Self-Piercing Riveting Technology...SPERT

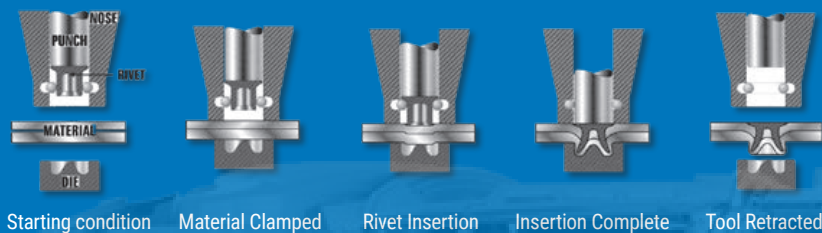

Industry Exclusive

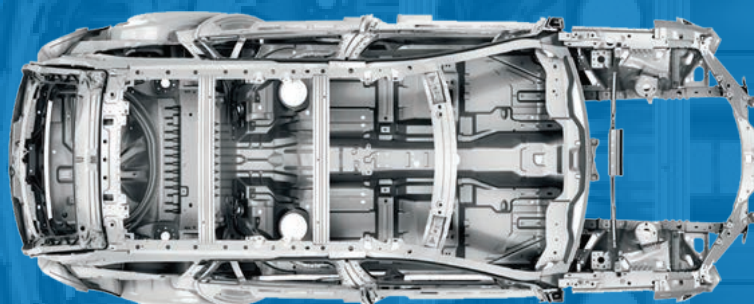

Over 3,000 Rivets are used in the body of the Jaguar XJ Series

What does this do for my pool?

Utilizing the same technology as the high-end automobile manufacturers, such as Jaguar, Audi and BMW, Only Alpha Pool Products offers a Lifetime Warranty against "SPERT" failure. Our competition's clinch/toggle lock can not only fail during installation but long after, breaking down the entire structural integrity of the wall system.

Installation... a little inconvenience, **A Lot of Rewards!!!**

The fact is, your backyard will be a construction site. When planned correctly by a professional and reputable independent pool contractor, the inconvenience is manageable and short-lived. The process begins by planning out the location of your pool. Then an excavation crew will strategically dig the area where your new pool will be, and the retaining walls and bracing systems will be set in place. After your contractor has secured the retaining walls, the pool's bottom will be formed so it will be ready for the pool liner. Once the liner is in place and all of the final finish processes are completed, all that remains is a lifetime of fun and relaxation. You'll be enjoying your new pool before you know it!

TITAN[®] STEEL





Your dealer/builder/contractor is an independent business person and not an agent or employee of Only Alpha Pool Products. We cannot and do not accept any responsibility for any representations, statements, or contracts made by any dealer/builder/contractor.

Entertaining is Guaranteed to Make a Splash...

When it comes to entertaining, nothing beats an in-ground pool. Relax with your friends and reminisce about the “good ol’ days”, or dive into an exciting game of water basketball. From family get-togethers to everyday life, owning a pool is sure to make your home the center of attraction.





Notice: “No Diving” signage may not be visible in some photos in this brochure, however such warning signage must be installed around the perimeter of each pool. The safety rope and float have been removed in some pictures for photographic purposes only. The safety rope should be attached at all times. All other safety components should be used in accordance to the manufacturer or PHTA standards.

A Real Liquid Asset...

A swimming pool is not only a great way to beat the heat. A pool is also a lasting investment in your property.

A recent study published by the National Association of Realtors maintains that an in-ground swimming pool can increase the value of homes from eight percent to as much as fifteen percent due to aesthetic charm and recreational appeal.

8-15%



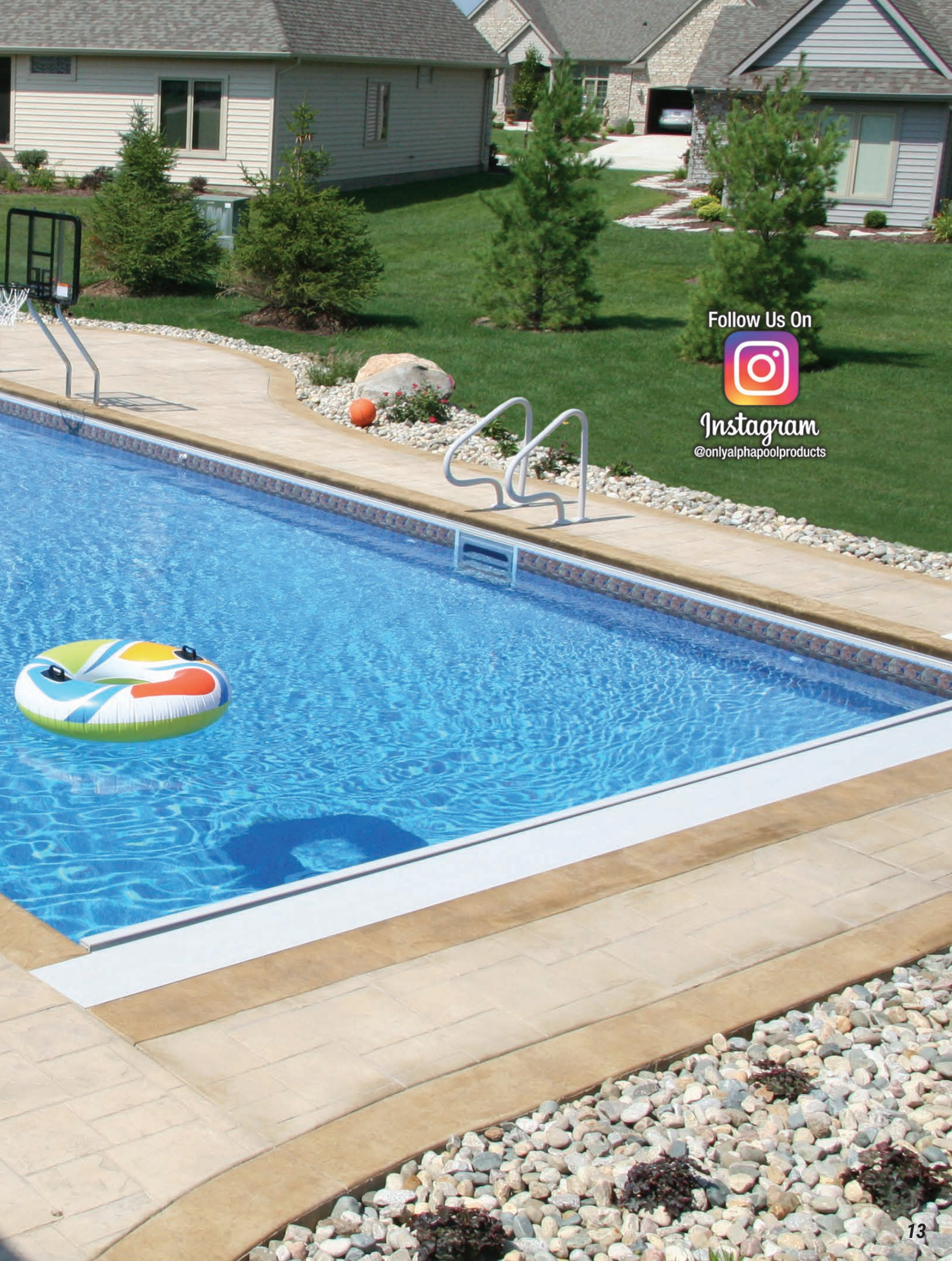

Follow Us On



Instagram

@onlyalphapoolproducts



Notice: "No Diving" signage may not be visible in some photos in this brochure, however such warning signage must be installed around the perimeter of each pool. The safety rope and float have been removed in some pictures for photographic purposes only. The safety rope should be attached at all times. All other safety components should be used in accordance to the manufacturer or PHTA standards.

No Better Way to End the Day...

Retreat to the solitude of your personal oasis
and forget about the worries of your busy day.

TITAN[®] STEEL

FOLLOW US ON
Pinterest
Only Alpha





Safety 1st
Safety 2nd
Safety Always!

Water is everywhere - community pools, lakes, and rivers. What better way to “waterproof” your loved ones than by teaching them to swim!. The lifelong benefits are immeasurable. Children who learn to swim are far less likely to become a tragic statistic from a water accident away from home.

With owning a pool also comes responsibility. There are many rules that must be followed around a pool. Protect yourself and your loved ones. Read and educate yourself with all literature that is available in the pool industry. Insist that your independent pool professional supply the industry publications that deal with pool safety, maintenance and the do’s and don’t’s around the pool. There are also many resources for information about pool safety on the internet. We recommend contacting Pool & Hot Tub Alliance. This national organization is the best resource for most swimming pool safety publications.



Pool & Hot Tub Alliance has excellent publications that are available. These publications can be ordered by calling or writing them at:



Pool & Hot Tub Alliance
 2111 Eisenhower Avenue
 Alexandria, VA 22314
 (703) 838-0083 or www.phta.org

Educate and supervise all bathers.

These are examples of safety information and signage. Be sure to ask your independent pool contractor for this information.





This “Area Warning Sign” is an example of the signage which must be permanently and conspicuously affixed in the pool area so it can be easily seen by everyone using the pool.

IMPORTANT!

“No Diving” signage must be installed on the coping around the perimeter of your pool. “Caution” signage also must be affixed to the steps.



Highly Customizable Shapes

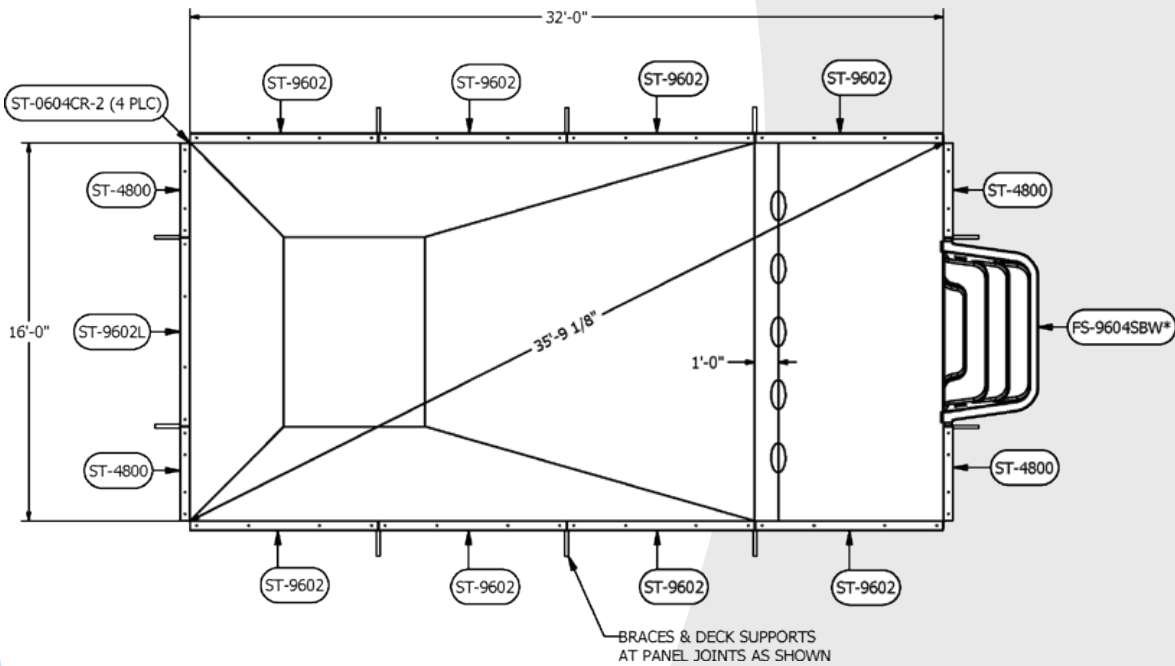

...Our state-of-the-art technology allows us to build any pool, any size, any shape, with excellent quality.

Any
Pool

Any
Size

Any
Shape

No
Limitations

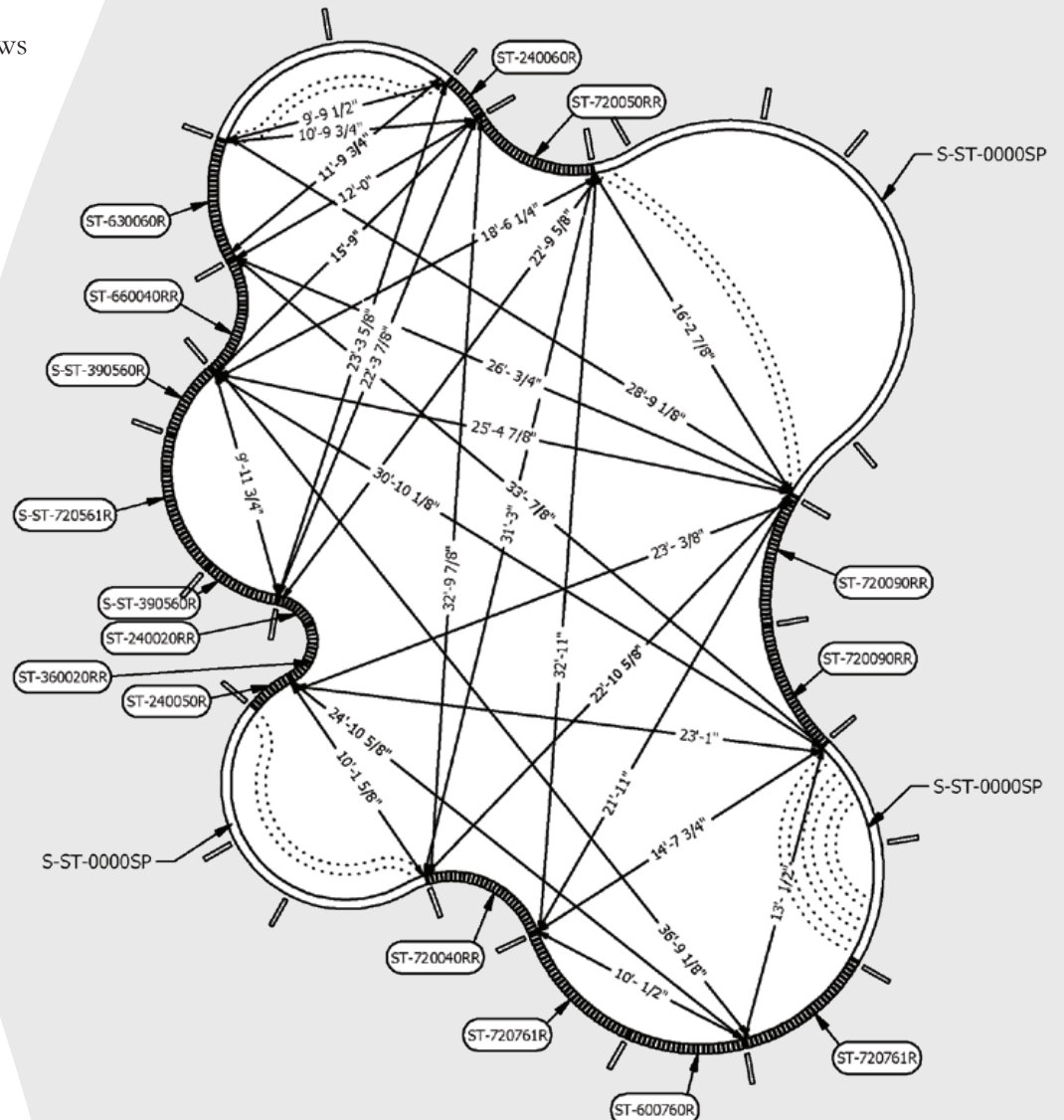

From Simple to Complex Your Vision Can Be a Reality



Swimming pools come in a variety of shapes and sizes, providing an endless amount of options to make your pool the perfect decision for your family. From free-form shapes to narrow lap pools, there is no wrong answer when it comes to the kind of pool you choose for your family. Important considerations are the available space for an installation and your budget. Pools can be very elaborate or elegantly simple. We encourage you to talk candidly with your independent pool professional to have all your questions answered before they turn over the first shovel of dirt. They are there to assist in making your dreams come true.

From classic to contemporary or geometric to linear.
What you envision...can be yours

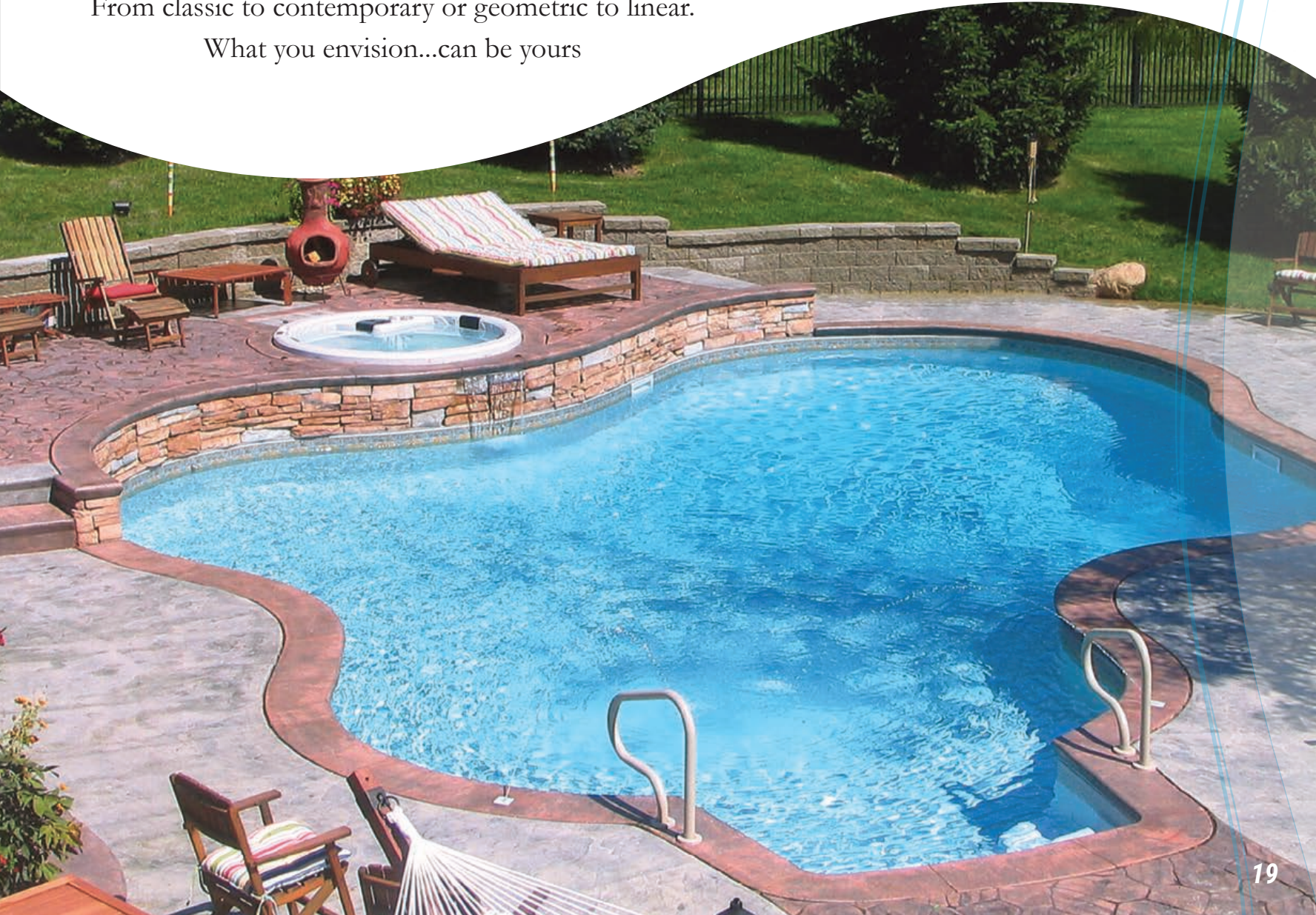

Entry Systems For Swimming Pools

Acrylic Fiberglass Steps

The snow-white, acrylic non-skid surface is reinforced with hand-laid, 100% pure fiberglass. Our 100% non-corrosive, easy-to-clean, acrylic-finished fiberglass steps are extremely strong and are impervious to the elements. By utilizing our standard direct support system, our acrylic-surface fiberglass steps install quickly and precisely. Our time-tested, proven gasket system assures an exact fit and permanent bond every time.

Thermoplastic Steps

Vacuum formed from a single sheet of ABS supported BASF Luran® ASA thermoplastic. Our thermoplastic steps are extremely strong, made to withstand the elements and are 100% non-corrosive. By utilizing our "Direct Support" reinforcement support system, our thermoplastic steps install quickly and precisely. Our time-tested, proven gasket system assures an exact fit and permanent bond every time.



The proven Alpha Advantage Shield Technology is embedded into every acrylic fiberglass step to help ensure they remain colorfast and easy to clean.

Largest Collection of Designs



Architect Gray



Lapis Blue



Standard White



Locking Straps and Rubber Gasket

Factory installed and easy to mount vinyl liner material

Structural Integrity

100% specialty engineered resins and fiberglass.

No filler, No additives!





Alpha Advantage Steel Steps

Liner Over Steps for Swimming Pools

State-of-the-Art Manufacturing Processes

- Computer Designed
- Automated Manufacturing
- Highly galvanized coating
- Alpha Advantage Shield
- SPERT Technology
- Highest quality certified 14-gauge copper bearing steel from ONLY USA suppliers

From a 5-Year Red Rust Warranty on our Alpha Advantage Shield to an Unlimited Transferable Lifetime Structural Warranty featuring our SPERT technology...

Permanent Form designs are simply filled with gravel and topped with concrete and foam, while Straight Tread designs include both risers and treads.

Regardless of your Step Design, exact dimensions allow a perfectly fit liner on every step.



From Concept to Completion...

Whether you envision your entry system to be a straight, radius, or combination of designs, we will help you create your dream pool, and manufacture it to your exact specification.

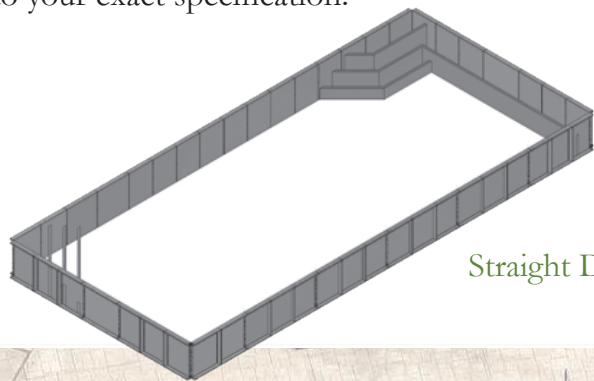

Straight Designs

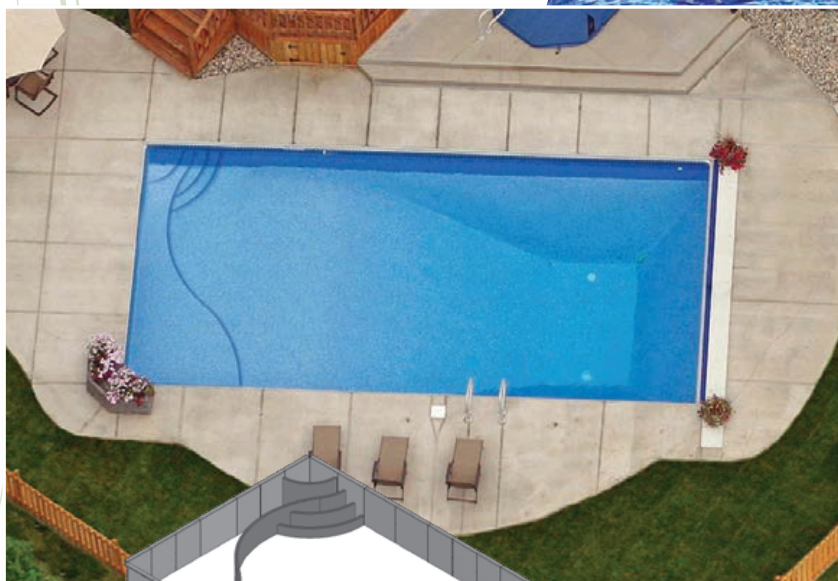

Radius Designs

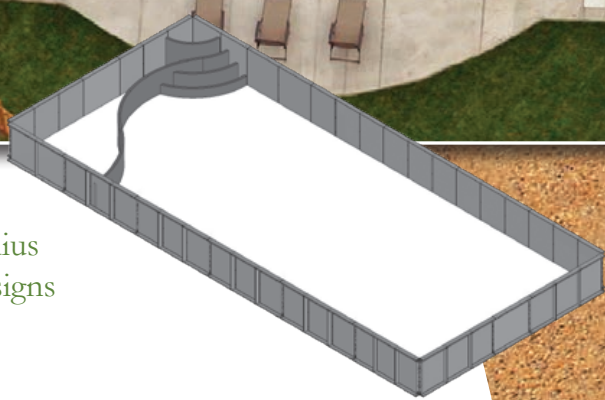



Vacation at Home

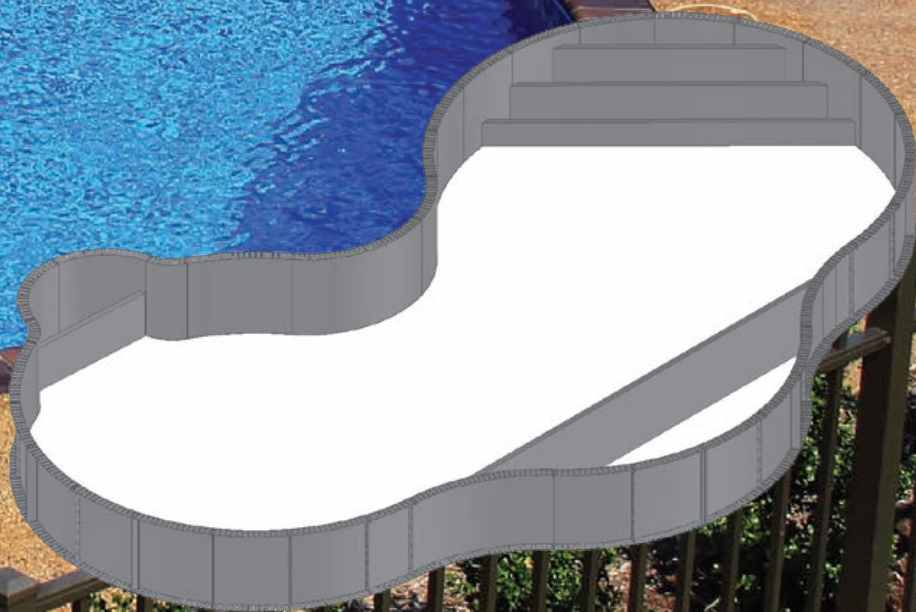

Dreams Become Reality





Vinyl Liners for Your Swimming Pool

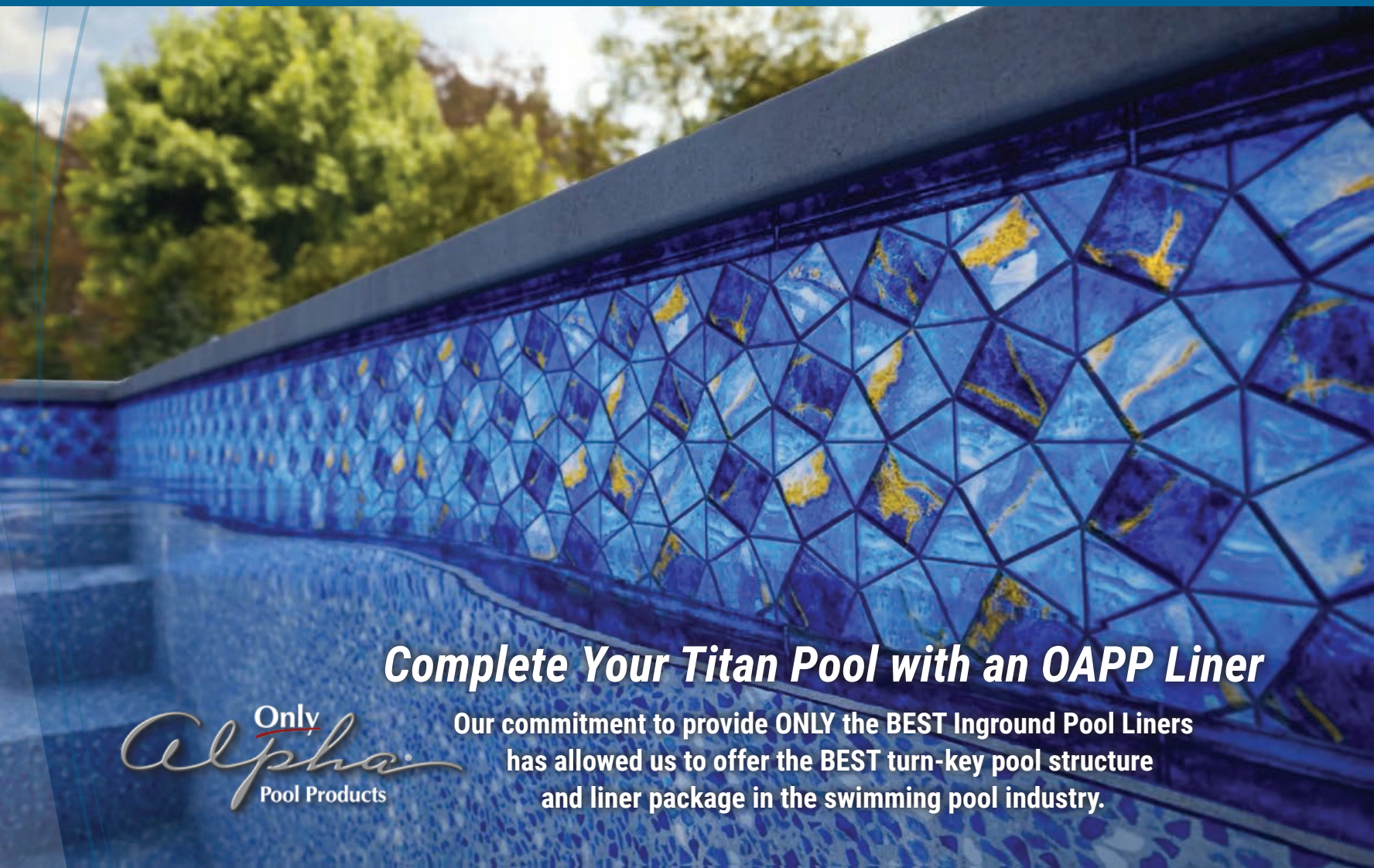

Complete Your Titan Pool with an OAPP Liner

Alpha
Pool Products

Our commitment to provide **ONLY** the **BEST** Inground Pool Liners has allowed us to offer the **BEST** turn-key pool structure and liner package in the swimming pool industry.

We Are Committed To Quality

- USA-Sourced, Premium Virgin Vinyl
- Every Liner CFFA P-101 Certified
- Latest Software Designs For Perfect Fit
- 25-year Pro-Rated Liner Warranty
- Offering An Exclusive Collection From Over 30 Patterns

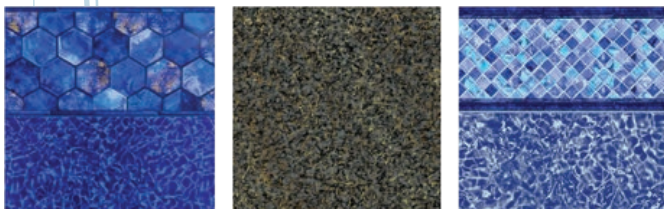

Certified For:
Material Thickness
Tear Resistance
Elasticity
Color
UV Stability





Only Alpha Pool Products does not manufacture or endorse diving boards or slides. Any use or installation of diving boards or slides must be in strict compliance with each such equipment manufacturers specifications and recommendations, the Pool & Hot Tub Alliance Standards, as well as all local building codes and regulations; and recommendations from the American Red Cross and the Consumer Product Safety Commission.



Vinyl Liner Pools... There is an Advantage!

- Pool components are manufactured in a controlled environment by machinery and have long manufacturer warranties.
- Easy and least expensive to repair as the pool consists of components.
- Replacing a liner is more economical than resurfacing other pool types.
- Some standard shapes like L-shapes provide a combination of large diving and shallow play areas.
- Can be custom designed to any shape and size and can achieve the high end look of a concrete pool without the high cost.
- Countless liner designs and color choices.
- Smooth surface is easy to clean and maintain and is skin friendly.
- Quality structures are self-supporting.

Concrete/Gunite Pools... Disadvantages

- Most expensive pool in the market and is difficult to clean and maintain.
- Surface is porous and most susceptible to damage caused by water chemistry.
- Must be resurfaced every 7-15 years at considerable cost.
- Plumbing is very expensive to repair as it is encased in concrete.
- Perimeter tile, which is necessary for these pools, is beautiful but requires maintenance and is susceptible to freezing damage.
- Surface can be rough on the feet and skin.
- Correct installation takes months and being concrete, it is prone to cracking and concrete cracks are very difficult to repair permanently.
- Pool is manufactured on site and there are very short if any warranties on pool surface and pool structure.



One piece Fiberglass Pools... Disadvantages

- Even the largest fiberglass pools are at best average in size and advertised sizes don't represent the true size of the usable pool.
- Cannot be custom designed to fit your individual taste, entertainment goals or landscaping desires.
- When the surface fades or deteriorates, it is very difficult and expensive to resurface.
- The structure is not self-supporting and may collapse or buckle if emptied.
- Difficult and expensive to repair and has the potential for very extensive damage.
- Suspiciously short warranties on some color surfaces and no warranties against floating or buckling.



only alpha pool products
DOWN SYNDROME
Advocacy Program



Our Mission...

Our mission is to promote water safety to individuals with Down syndrome and/or other disabilities who are twice as likely to drown due to lack of water safety skills. Only Alpha Pool Products is dedicated to helping reduce drowning statistics by offering financial support to swim instructors seeking to receive swim certifications to teach a more adaptive approach for individuals with disabilities as well as financially supporting organizations who offer tailored swim lessons to the disability community.

Get Involved and Support this wonderful cause!

The pool photographs in this brochure are for illustrative purposes only. The pools were constructed using individual components from many different manufacturers.

2024 Only Alpha Pool Products
All rights reserved.

Only Alpha Pool Products stands behind every product we produce pursuant to those representations which are stated in our written warranty. Your dealer/builder/contractor is an independent business person and not an agent or employee of Only Alpha Pool Products. We cannot and do not accept any responsibility for any representations, statements or contracts made by any dealer/builder/contractor.



Construction components manufactured by:
Only Alpha Pool Products
4404 Engle Ridge Drive
Fort Wayne, Indiana 46804
Phone: 260.637.0141
Fax: 260.203.5640
www.onlytitan.com