



**High Performance Building Materials  
for Swimming Pools**





*Fuzion is the Beginning of Spectacular...*









# Why Buy an Only Alpha Pool Products Pool?

## Only the Best Materials

### High Performance Building Materials for Swimming Pools

- Highly Engineered Reinforced Composites
- 42" Wall Heights
- Up to 6' Maximum Panel Length
- Radius and Straight Panels



## Complete Pool Package

### 5-Day Manufacturing Lead Time, complete with liner, delivered safely and quickly anywhere!

Carefully loaded and shrink-wrapped pallets are easily identified and ready to build on your jobsite. Our fleet of delivery trucks and fulfillment centers means you are assured your job will be onsite when you're ready for it.



Following through on our commitment to provide ONLY the best by adding Inground Pool Liners to our in-house offering. This allows us to provide the BEST turn-key pool structure and liner package in the business.



## Only the Best People

### Our Experienced and Dedicated Workforce are the Best!

Having a dedicated workforce means our team members are constantly striving to achieve perfection in every aspect of their jobs. Our craftsmen have been with us for years and are cross-trained to be experts at everything they do. They utilize state-of-the-art equipment that produces our panel components and take incredible pride in all facets of their jobs.



...We Are OAPP



# Go Ahead...Suddenly It's Easy to Find Time



Commitments and everyday schedules make it more and more difficult to take the time to do the things that you REALLY enjoy. Spend quality time with your family. Have a game of pool volleyball with friends. Just chill out by the pool soaking in the sun's rays.





# What is FUZION? Building Materials of the 21st Century

**Evaluated and in Compliance with over 30 Codes and Standards Including International Building, Residential, and Swimming Pool & Spa**



All of our highly-engineered panels have been ICC-ES Evaluated, receiving a comprehensive compliance report. This underscores our unwavering commitment to providing Only the BEST building materials, held to the most rigorous quality control and building standards in the WORLD.

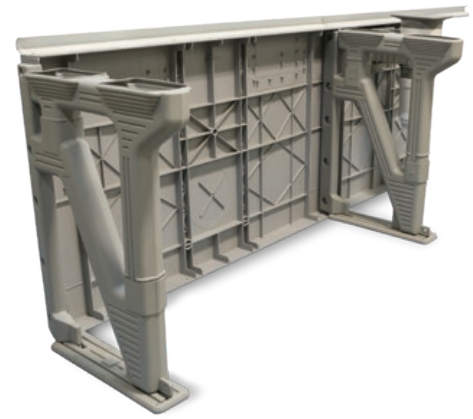

Scan this QR CODE to view our ICC-ES Evaluation Report



*High Performance Building Material for Swimming Pools*

**A complete swimming pool and brace system of highly engineered reinforced composites.**



Scientists and lab techs created **Fuzion 5010** highly engineered reinforced composite by utilizing advanced material design techniques and thoroughly evaluating the product's end use to develop the perfect material for the **Fuzion 5010** construction components.

## Updating the Pool Industry

### NEW TECHNOLOGY

#### Fuzion 5010 Highly Engineered Composite

- Thermoset composite material (polymer, resins, fibers)
- Structurally reinforced (fused fiber matrix)
- Extremely high strength-to-weight ratio
- High impact resistance, flexural & tensile strength
- Non-corrosive (won't oxidize, rot, or rust)
- Impossible to melt or re-shape after molding
- Non-reversible process
- Long lifespan

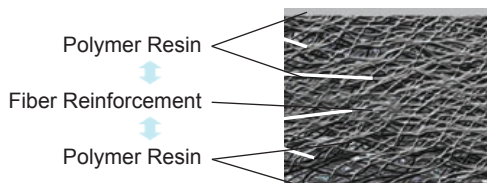

### OLD TECHNOLOGY

#### Structural Foam Polystyrene Plastic

- Low impact resistance, low flexural & low tensile strength
- Structurally reinforced using air pocket corrugation
- Thermoplastic material
- Good strength to weight ratio
- Non-corrosive
- Warps, bends, bows or deforms after molding with mild heat / cold
- Melts with extreme heat +300 degree

Expanding Foam

Inert Gas causing foam to expand

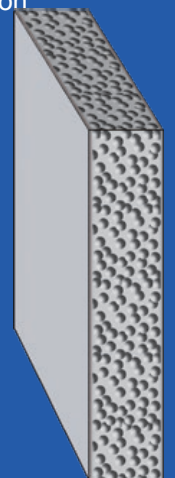
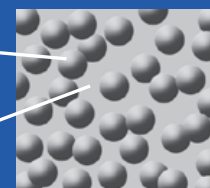



# Patented Retaining Wall & Bracing System

Patented Flats & Compression Plates Eliminate Virtually All Debris/Water Seepage

Superior Dimensional Stability

Highly Engineered Pillar Support & Cross Support Beam

Highly Engineered Ribbing Lends Unrivalled Strength

Oversized 6" Deck Support



Scan this QR CODE to launch a YouTube video and watch a Pool Installation



**LIFETIME  
TRANSFERABLE  
WARRANTY!**





**Highly Engineered Reinforced Composites** have revolutionized entire industries such as the Aerospace, Automotive, Military, Agriculture, Construction and Energy because of its infinite applications and unprecedented performance.

### ***Common Reinforced Composite Applications:***

- Structural Truck Bed components used commonly in the Auto Industry
- Wings and Nose Cones for Fighter Jets and Airplanes
- Exterior Components for Military Tanks and Humvees
- Composite I-Beams and Rebar for Bridge Construction
- Composite Siding, Decking, Shingles, for Home Building Industry



*Composite Seawall, Tampa, FL*

### ***Hurricane Proof***

Composites are strong enough to hold an ocean from a continent.

### ***Resistant to Salt***

Salt generators can be used with composite pools without fear of decomposing material.

## **The Evolution of Materials Used In Swimming Pools**

**1950's** - Inground pool wall material started with wood. Low strength and low longevity.

**1960's** - Inground pool wall material transitioned to steel. This added strength but little in additional longevity.

**1970's** - Inground pool wall material transitioned to plastic structural foam. Plastic pool walls added greatly to longevity but reduced strength dramatically from steel or wood.

**2000's** - Inground pool wall material using NEW Highly Reinforced Composite Material Technologies allows superior strength to meet or exceed steel with unsurpassed longevity. ***The Material of the 21st Century!***

Only Alpha Pool Products  
Composite Wall System  
U.S. Patents 8,505,247 and 8,215,069



Scan this QR CODE to find more information about Composites



*Designed and built by Long Island Pool and Patio*



## 4 Major Benefits of Using **Fuzion 5010** Highly Engineered Reinforced Composite

- |          |                              |   |
|----------|------------------------------|---|
| <b>1</b> | <b>Design Versatility</b>    | Can be molded to produce almost any shape desired—large or small, as well as simple or complex. Endless design possibilities with <b>Fuzion 5010</b> .  |
| <b>2</b> | <b>Dimensional Stability</b> | Maintain their shapes under intense mechanical and environmental stresses. <b>Fuzion 5010</b> will maintain its shape permanently.  |
| <b>3</b> | <b>Corrosion Resistance</b>  | Do not rust or corrode, and offer various levels of chemical and environmental resistance. <b>Fuzion 5010</b> will withstand acidic or any other corrosive elements in the soil.                                    |
| <b>4</b> | <b>Unparalleled Strength</b> | Are designed to produce a wide range of impact, tensile, and flexural strength properties. <b>Fuzion 5010</b> won't warp or deform, crack or shear regardless of soil or climate conditions. (See written warranty) |

## Composites are Energy Efficient

Based upon Thermoconductivity (W/m•K) or the transfer of heat and cold, composite materials and other plastics rank as the best insulators at a 0.3 W/m•K. Portland cement, which is often used on the bottom of many vinyl pools is also 0.3 W/m•K. Compare this with other materials used for pools: Concrete at 1.7 W/m•K, Steel at 43 W/m•K, Zinc at 116 W/m•K, and Aluminum at 250 W/m•K.

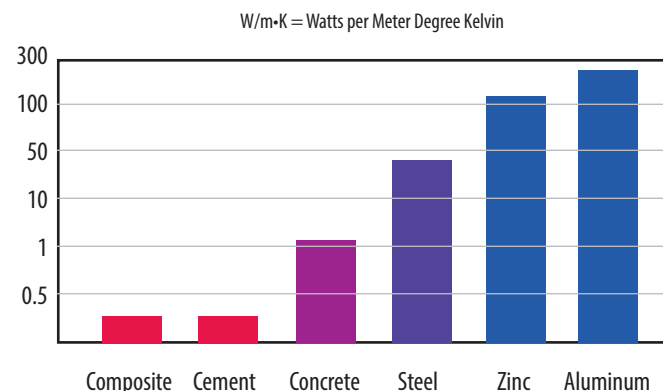

## Installation...A little Inconvenience **A Lot of Rewards!**



The fact is, your backyard will be a construction site. When planned correctly by a professional and reputable independent pool contractor, the inconvenience is manageable and short-lived. The process begins by planning out the location of your pool. Then an excavation crew will strategically dig the area where your new pool will be, and the retaining walls and bracing systems will be set in place. After your contractor has secured the retaining walls with a concrete footer, the pool's bottom is formed with concrete or vermiculite so it will be ready for the pool liner. Once the liner is in place and all of the final finishing processes are completed, all that remains is a lifetime of fun and relaxation. You'll be enjoying your new pool before you know it!





# Backyard Serenity



Your dealer/builder/contractor is an independent business person and not an agent or employee of "Only Alpha Pool Products". We cannot and do not accept any responsibility for any representations, statements or contracts made by any dealer/builder contractor.



# Backyard Entertainment



Only Alpha Pool Products does not manufacture or endorse diving boards or slides. Any use or installation of diving boards or slides must be in strict compliance with each such equipment manufacturers specifications and recommendations, the Association of Pool and Spa Professionals Standards, as well as all local building codes and regulations; and recommendations from the American Red Cross and the Consumer Product Safety Commission.



# Highly Customizable Shapes

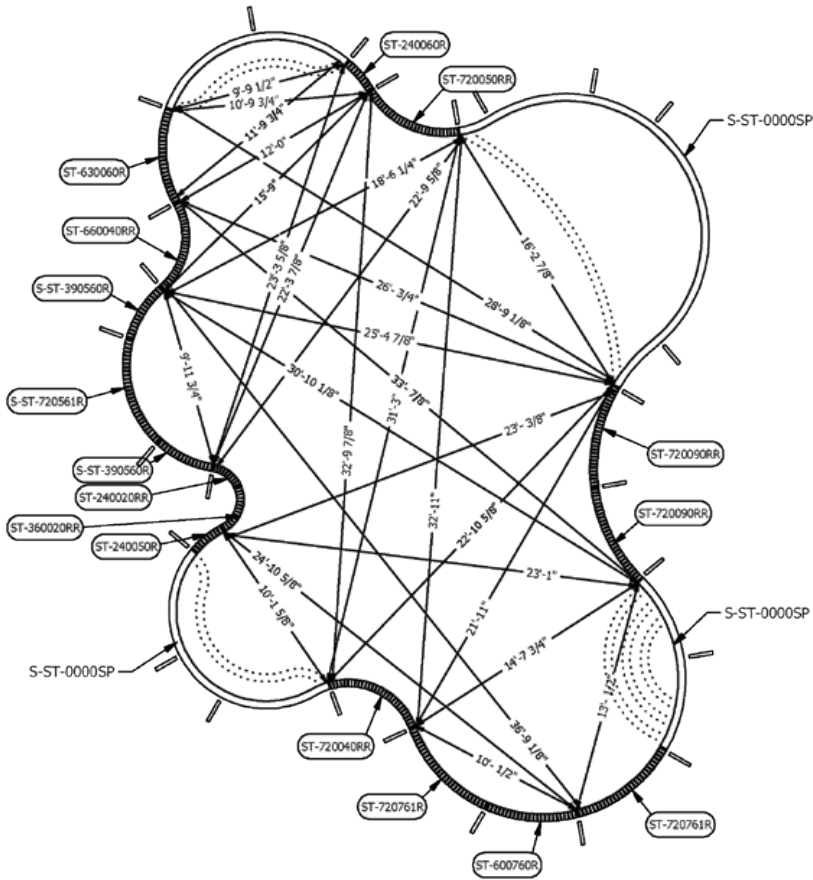

Our state-of-the-art technology allows us to build any pool, any size, any shape, with excellent quality.

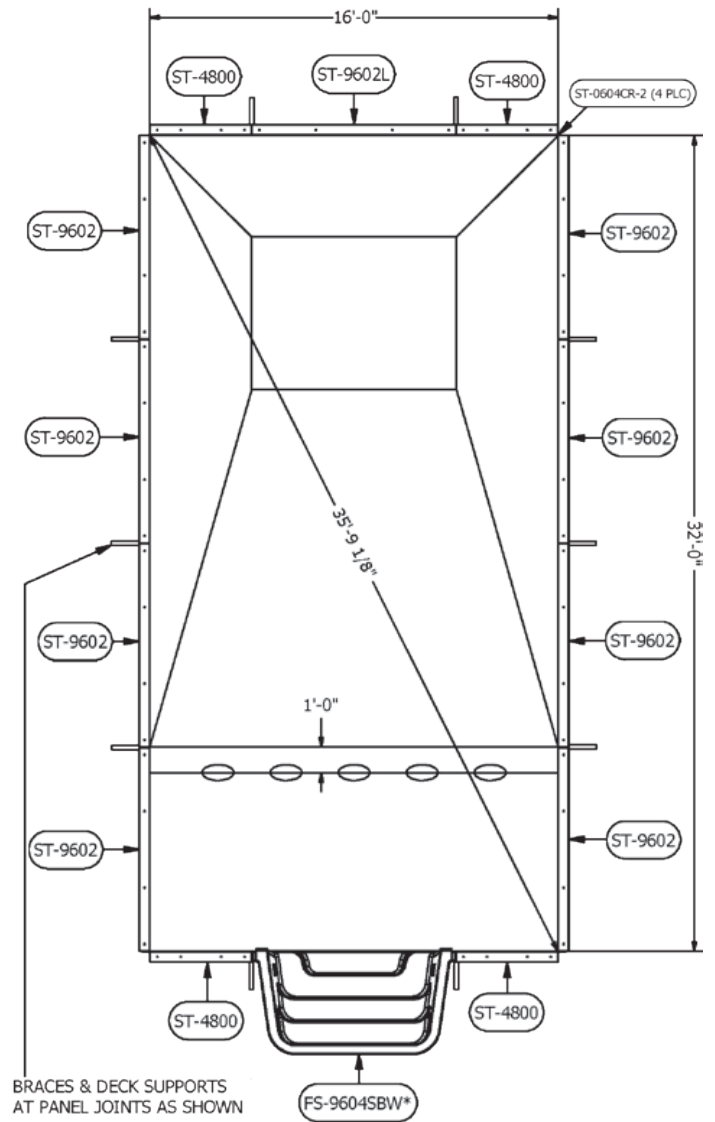

## Composite Step & Brace Program Enhancements



**Builds like steel and features radius and straight pre-engineered step systems**

We renovated our existing composite step system by upgrading to a componentized program consisting of pre-engineered steps and braces to allow for quicker and easier ordering and installation process.







*Designed and built by Long Island Pool and Patio*



We're so confident in the strength of the **Fuzion 5010** substructure components, that we offer an unlimited transferable lifetime warranty.



**Notice:** Although in some photos of the pools in this brochure the No Diving signage may not be visible, such warning signage must be installed around the perimeter of each pool.





# Fiber-Reinforced Composite Steps

## Liner Over Steps For Swimming Pools





# Your Project, Endless Possibilities

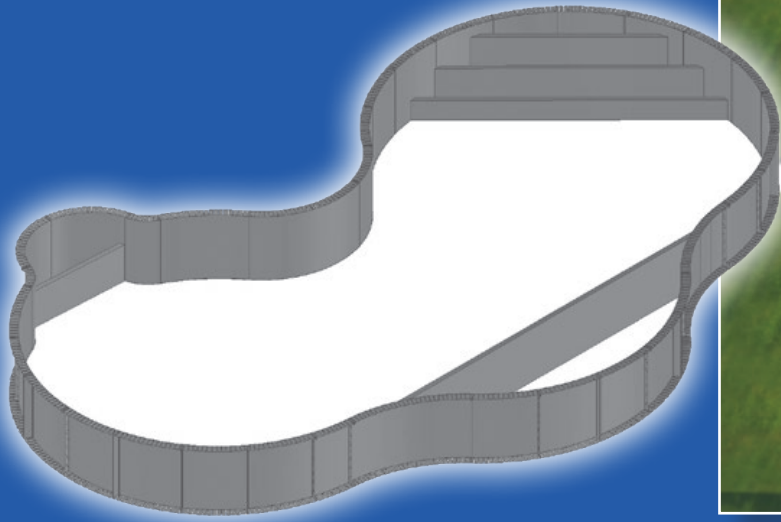

...to Completion

From Concept...

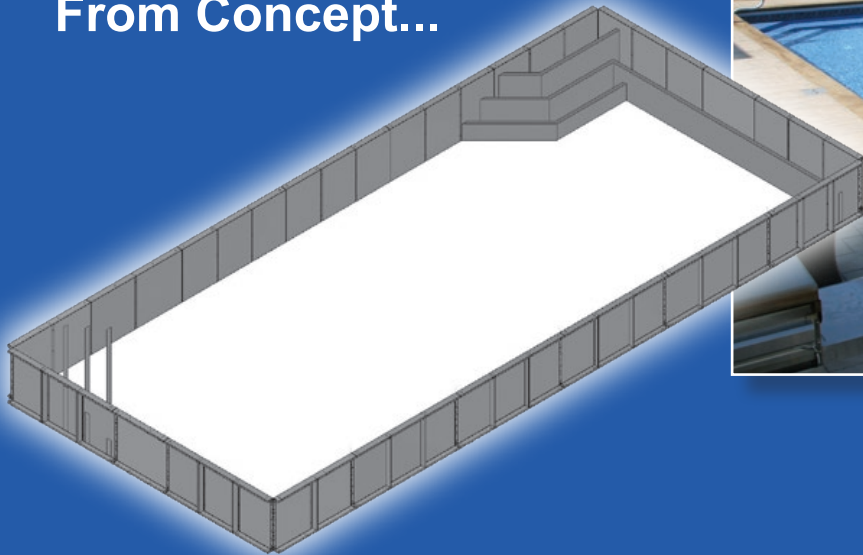

Only  
*Alpha*  
Pool Products





# Safety 1<sup>st</sup> Safety 2<sup>nd</sup> Safety Always!

Water is everywhere - community pools, lakes, and rivers. What better way to “waterproof” your loved ones than by teaching them to swim!. The lifelong benefits are immeasurable. Children who learn to swim are far less likely to become a tragic statistic from a water accident away from home.

With owning a pool also comes responsibility. There are many rules that must be followed around a pool. Protect yourself and your loved ones. Read and educate yourself with all literature that is available in the pool industry. Insist that your independent pool professional supply the industry publications that deal with pool safety, maintenance and the do’s and dont’s around the pool. There are also many resources for information about pool safety on the internet. We recommend contacting Pool & Hot Tub Alliance. This national organization is the best resource for most swimming pool safety publications.



Pool & Hot Tub Alliance has excellent publications that are available. These publications can be ordered by calling or writing them at:



Pool & Hot Tub Alliance  
2111 Eisenhower Avenue  
Alexandria, VA 22314  
(703) 838-0083 or [www.phta.org](http://www.phta.org)

Educate and supervise all bathers.

These are examples of safety information and signage. Be sure to ask your independent pool contractor for this information.





# Pool Safety at All Times



This “Area Warning Sign” is an example of the signage which must be permanently and conspicuously affixed in the pool area so it can be easily seen by everyone using the pool.

## IMPORTANT!

“No Diving” signage must be installed on the coping around the perimeter of your pool. “Caution” signage also must be affixed to the steps.

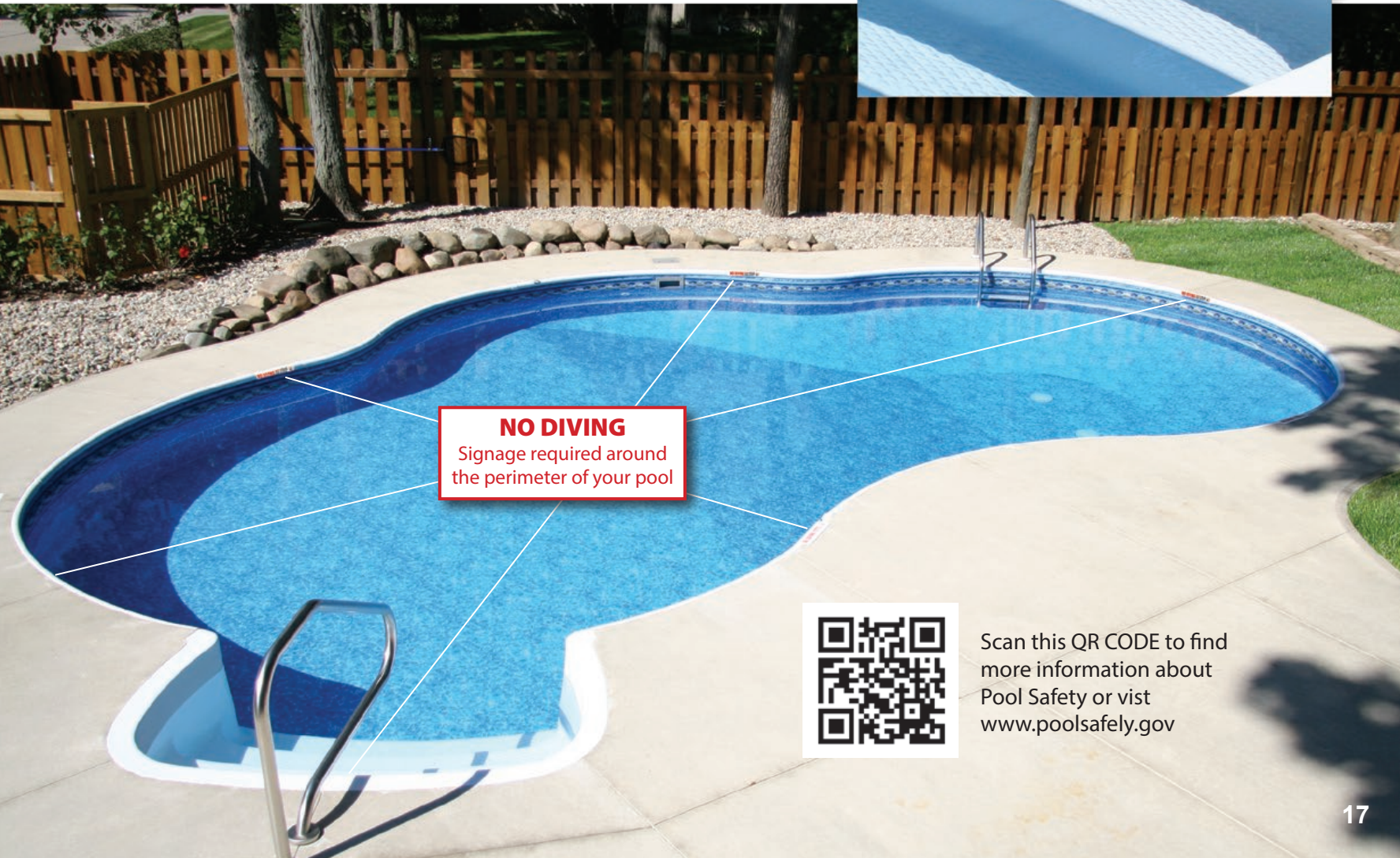

Scan this QR CODE to find more information about Pool Safety or visit [www.poolsafely.gov](http://www.poolsafely.gov)



# Vinyl Liners For Your Swimming Pool

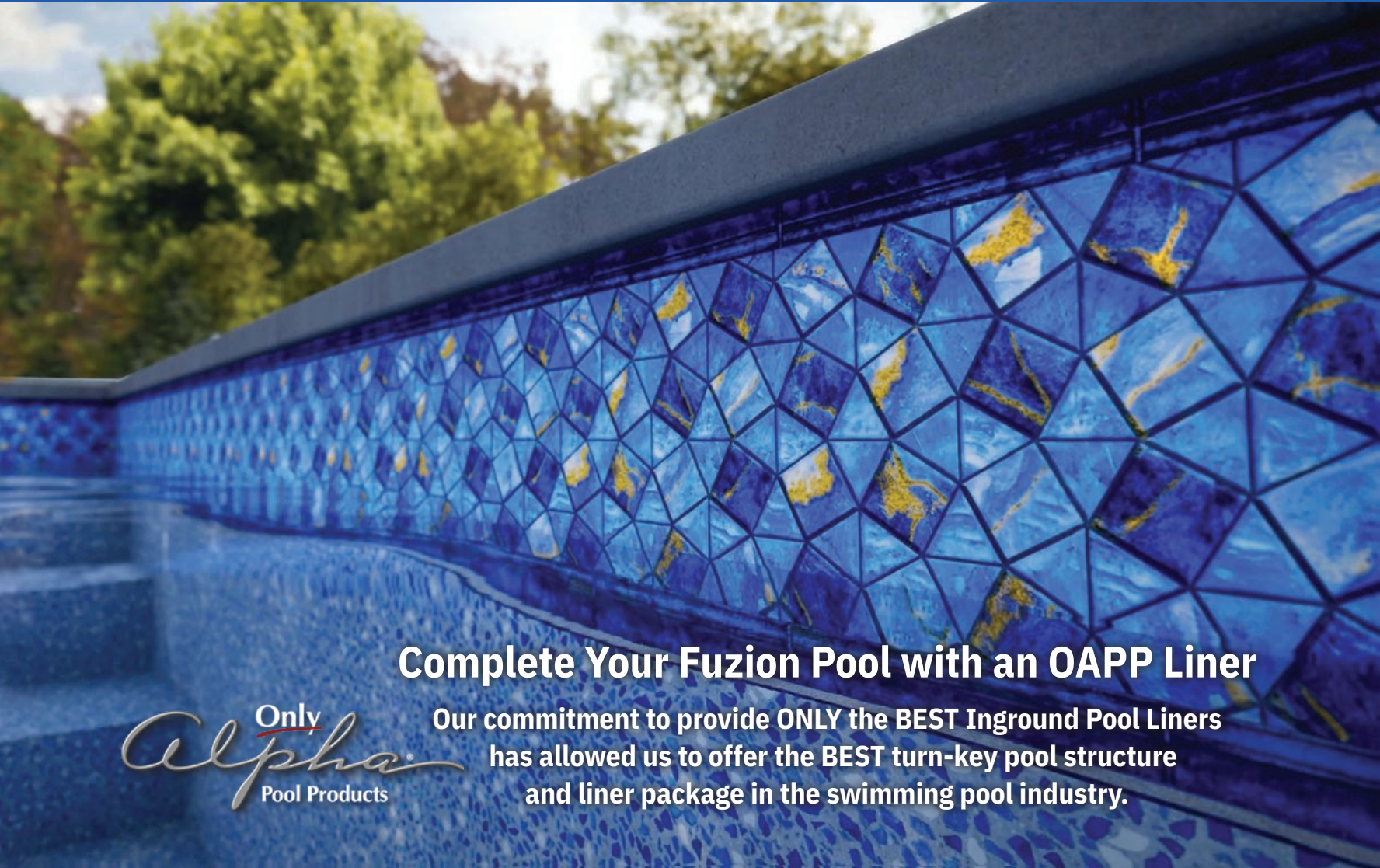

## Complete Your Fuzion Pool with an OAPP Liner



Our commitment to provide **ONLY** the **BEST** Inground Pool Liners has allowed us to offer the **BEST** turn-key pool structure and liner package in the swimming pool industry.

### We Are Committed To Quality

- USA-Sourced, Premium Virgin Vinyl
- Every Liner CFFA P-101 Certified
- Latest Software Designs For Perfect Fit
- 25-year Pro-Rated Liner Warranty
- Offering An Exclusive Collection From Over 30 Patterns

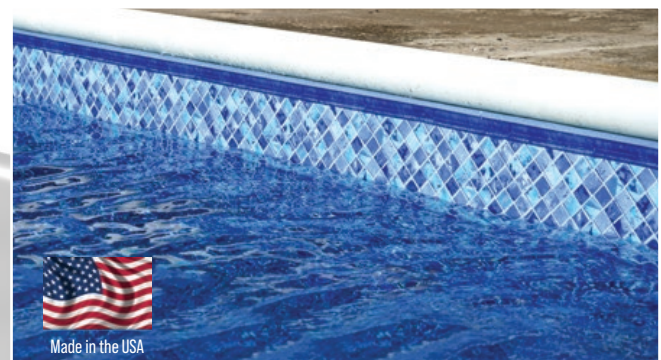
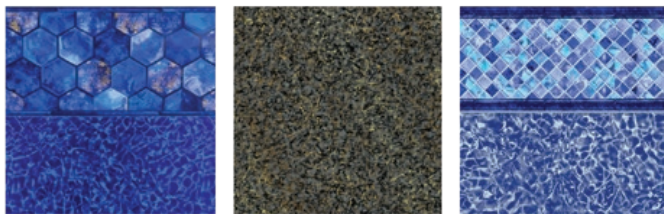





Only Alpha Pool Products does not manufacture or endorse diving boards or slides. Any use or installation of diving boards or slides must be in strict compliance with each such equipment manufacturers specifications and recommendations, the Association of Pool and Spa Professionals Standards, as well as all local building codes and regulations; and recommendations from the American Red Cross and the Consumer Product Safety Commission.

## Vinyl Liner Pools...There is an Advantage!

- Pool components are manufactured in a controlled environment by machinery and have long manufacturer warranties.
- Easy and least expensive to repair as the pool consists of components.
- Replacing a liner is more economical than resurfacing other pool types.
- Some standard shapes like L-shapes provide a combination of large diving and shallow play areas.
- Can be custom designed to any shape and size and can achieve the high end look of a concrete pool without the high cost.
- Countless liner designs and color choices.
- Smooth surface is easy to clean and maintain and is skin friendly.
- Quality structures are self-supporting.



### Concrete/Gunite Pools...Disadvantages

- Most expensive pool in the market and is difficult to clean and maintain.
- Surface is porous and most susceptible to damage caused by water chemistry..
- Must be resurfaced every 7-15 years at considerable cost.
- Plumbing is very expensive to repair as it is encased in concrete.
- Perimeter tile, which is necessary for these pools, is beautiful but requires maintenance and is susceptible to freezing damage.
- Surface can be rough on the feet and skin.
- Correct installation takes months and being concrete, it is prone to cracking and concrete cracks are very difficult to repair permanently.
- Pool is manufactured on site and there are very short if any warranties on pool surface and pool structure.



### One piece Fiberglass Pools...Disadvantages

- *Even the largest fiberglass pools are at best average in size and advertised sizes don't represent the true size of the usable pool.*
- *Cannot be custom designed to fit your individual taste, entertainment goals or landscaping desires.*
- *When the surface fades or deteriorates, it is very difficult and expensive to resurface.*
- *The structure is not self-supporting and may collapse or buckle if emptied.*
- *Difficult and expensive to repair and has the potential for very extensive damage.*
- *Suspiciously short warranties on some color surfaces and no warranties against floating or buckling.*







only alpha pool products  
**DOWN SYNDROME**  
Advocacy Program



## Our Mission...

Our mission is to promote water safety to individuals with Down syndrome and/or other disabilities who are twice as likely to drown due to lack of water safety skills. Only Alpha Pool Products is dedicated to helping reduce drowning statistics by offering financial support to swim instructors seeking to receive swim certifications to teach a more adaptive approach for individuals with disabilities as well as financially supporting organizations who offer tailored swim lessons to the disability community.

**Get Involved and Support this wonderful cause!**



*The pool photographs in this brochure are for illustrative purposes only.  
The pools were constructed using individual components from many different manufacturers.*



Construction components manufactured by:

Only Alpha Pool Products  
4404 Engle Ridge Drive  
Fort Wayne, Indiana 46804  
Phone: 260.637.0141  
Fax: 260.203.5640

[www.onlyfuzion.com](http://www.onlyfuzion.com)

2024 Only Alpha Pool Products  
All rights reserved.

Only Alpha Pool Products stands behind every product we produce pursuant to those representations which are stated in our written warranty. Your dealer/builder/contractor is an independent business person and not an agent or employee of Only Alpha Pool Products. We cannot and do not accept any responsibility for any representations, statements or contracts made by any dealer/builder/contractor.